

| | | | | | | |
|-------------------------|-----------------|--------------|----------------|------------------|-------------------|--------------------|
| Tolerance ISO 2768-m | >0.5 =3 ±0.1 | > =6 ±0.1 | >6 =30 ±0.2 | >30 =120 ±0.3 | >120 =400 ±0.5 | >400 =1000 ±0.8 |
| | | | | | | |

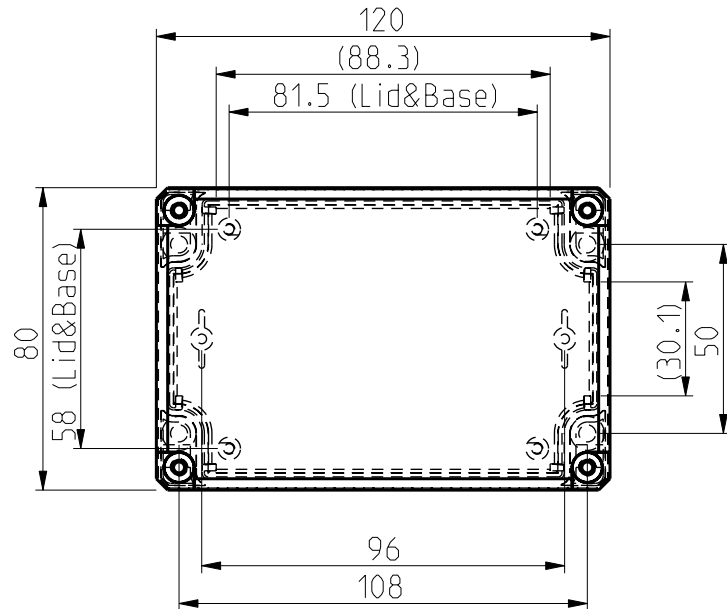

ENSTO
ENSTO CONTROL OY

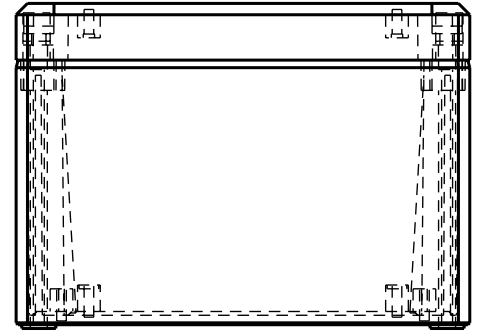
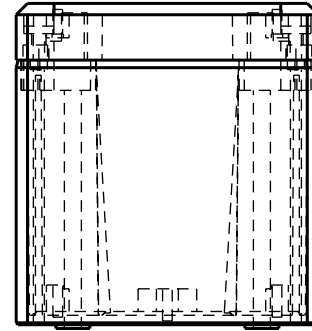
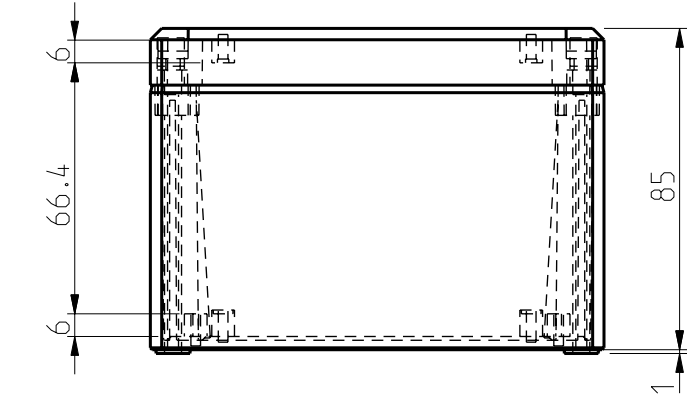
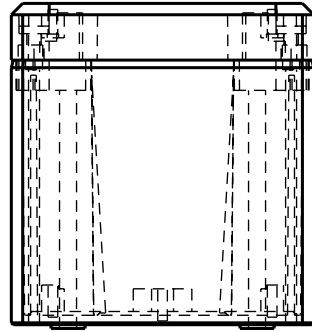
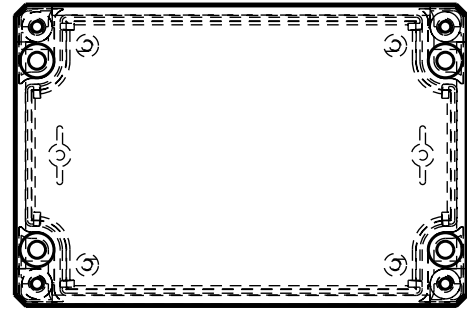
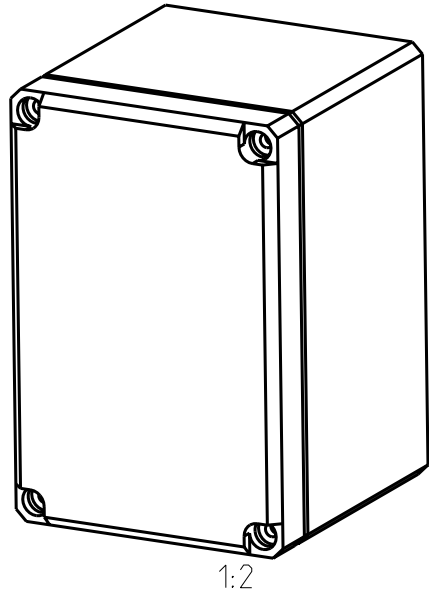
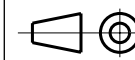

| | | |
|-------|---------|----------|
| Scale | Date | 21.10.04 |
| 1:2 | By | MPL |
| - | Checked | |
| - | Ctrl | |

CUBO D
DPCP 081209 G/T
DABP 081209 G/T

| | |
|-----------|-------|
| Replaces: | |
| Replaced: | |
| Drw No: | - |
| Ref: | - |
| Code: | - |
| Sheet No: | 1 (1) |